

SHARP

Be Original.

MX-C300
MX-C250

Digital Full Colour Multifunctional System



3-in-1 Convenience
from a Stylishly Compact Colour
A4 Solution



The Sleek, Practical Way to Bring 3-in-1 Efficiency to Your Business

Small in size but big on style and performance, this compact colour A4 MFP—with a footprint of just 429 × 509 mm—can bring convenient three-in-one functionality to any workplace. Ideal for streamlining the business operations of small workgroups in large offices or as the solo document performer in SOHO, small shops, and more, the MX-C300/C250 copies, prints, and scans with ease.

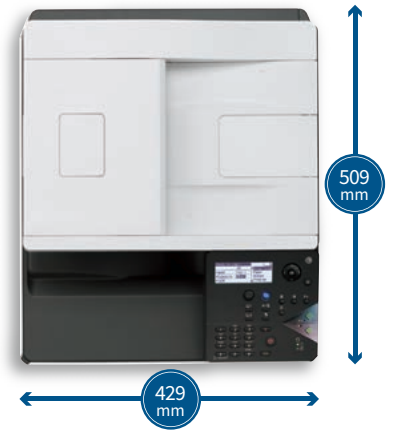

COPYING AND PRINTING

Efficient Colour and B/W Output

The MX-C300/C250 delivers a fast output of 30/25 cpm/ppm* in full colour and in B/W. And the first copy comes out in just 10 seconds in B/W and 18 seconds in full colour to save valuable time when performing multiple short-run jobs. A warm-up time of just 29 seconds brings added efficiency.

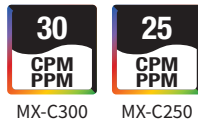

* A4 (8 1/2" x 11"), short-edge feeding

Superb Image Quality

Sharp's latest 3rd-generation **Mycrostoner-HG** (High Grade) and a dual-component developer system combine to provide breathtaking image quality. The toner's smaller particle size reduces graininess and enables clear reproduction of fine lines, fine text, and halftone colours.



Effective Paper Handling

The MX-C300/C250 comes standard with a 250-sheet paper tray and a 50-sheet multi-bypass tray. A 500-sheet paper feed unit is optionally available for a total paper capacity of 800 sheets. The MX-C300/C250 can also accommodate heavy paper up to 220 g/m², expanding the range of possible printing applications.

Built-In Duplex Module

The MX-C300's standard-equipped 50-sheet RSPF (reversing single pass feeder) and the MX-C250's 35-sheet SPF (single pass feeder) ensure efficient document feeding. Both the MX-C300 and the MX-C250 can also make two-sided copies and printouts using a built-in stackless duplex module, effectively reducing paper costs as well as saving filing space.



MX-C300

ID Card Copy

The MX-C300/C250 has a dedicated key for easy copying of both sides of a card (ID cards, credit cards, etc.) onto a single page.

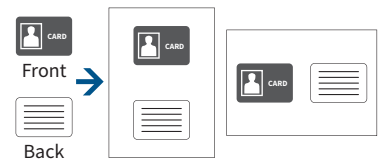

Direct Printing

The MX-C300/C250 can print PDF, TIFF, and JPEG files without using the printer driver. And there's a USB port beneath the control panel, which comes in handy when printing data directly from USB memory devices—an indispensable function for users who are in a hurry or who want quick machine access without a PC.

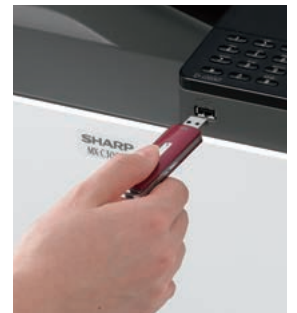

Network Printing

The MX-C300/C250 works as a network printer with the latest and most commonly used operating systems and network protocols, including IPv6, and even in mixed OS environments. It also supports, as standard, the PCL 6 and PostScript® 3™ printer languages.

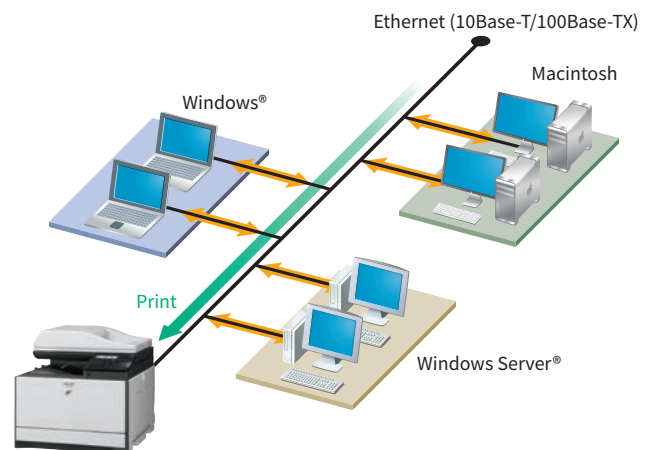

Full-Colour Network Scanning

The MX-C300/C250 works as a full-colour network scanner and supports TIFF, PDF, and JPEG file formats. Converting any type of paper-based document into an editable digital file is as easy as making a copy.

Multiple Distribution of Scanned Files

You can choose different ways to distribute your scanned documents: for example, send as an e-mail attachment or scan directly to an FTP server for storage.

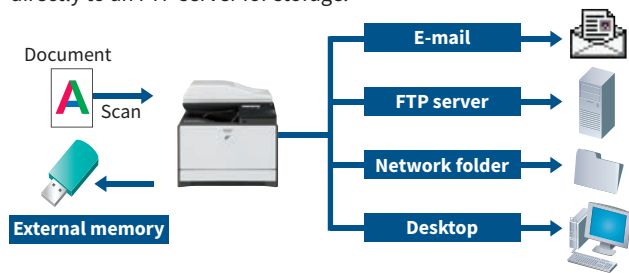

Business Card Scanning MX-C300

The MX-C300 can easily scan business cards* with its RSPF and can be used with commercially available business card scan software to create business card databases.



* One-sided scanning

Scanner Program Keys

Two Scanner Program Keys on the control panel enable users to register frequently used scan settings and destinations for easy, one-touch recall.

Sharpdesk

Sharpdesk is an original Sharp application that provides integrated desktop management of documents in over 200 file formats, including scanned images and documents created with popular applications such as Word. With Sharpdesk, documents can be organised, edited, searched, and distributed with simple drag-and-drop operation. Features include thumbnail viewing, annotation tools for paper-free proofreading, optical character recognition, the ability to combine different types of files into a single document, and more.

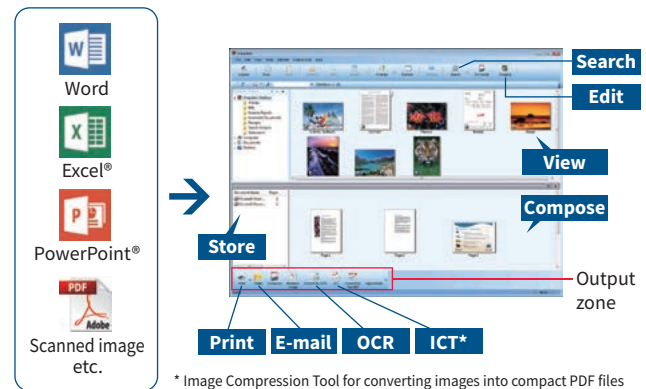

LDAP Support

Built-in LDAP (lightweight directory access protocol) support eliminates the need to enter or register full addresses. Entering just the first few letters of a recipient's name prompts the MX-C300/C250 to display a list of possible matches from your company's LDAP server. Selected addresses can be stored to the MX-C300/C250's address book.

OTHER OUTSTANDING FEATURES

Reliable Security

- IPsec data encryption technology ensures secure network communications.
- User authentication covering up to 30 users prevents unauthorised MFP use by requiring access passwords.
- Retained data can be initialised when it's time to replace the MFP, preventing the leakage of confidential information.

Sharpdesk Mobile*

Sharpdesk Mobile is a mobile print/scan application that combines the convenience of mobile devices and the efficiency of Sharp MFPs to make conducting business on the go easier than ever. Documents scanned on a Sharp MFP can be sent to a mobile device to preview and save. Documents saved on a mobile device can be printed out on the MFP, sent as e-mail attachments, or used in other applications.

* Availability varies by country/region. For details, see the Sharpdesk Mobile support website:
http://sharp-world.com/products/copier/docu_solutions/mobile/sharpdesk_mobile/

Easy-To-Use Control Panel

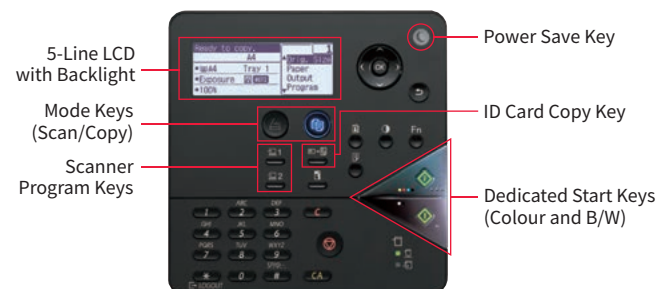

Network Utility Software

Sharp Remote Device Manager* (SRDM) gives administrators centralised control of their networked MFPs through a standard Web browser, making device cloning and other operations easier and more accessible.

* Contact a Sharp customer representative for availability and other details.

SPECIFICATIONS (tentative)

General

Type	Desktop
Engine speed	A4 (8 1/2" x 11")*1: Max. 30/25 ppm
Control panel display	5-line LCD
Paper size	Max. A4 (8 1/2" x 14"), min. A6 (5 1/2" x 8 1/2")
Paper capacity (80 g/m ²)	Standard: 300 sheets (250-sheet tray and 50-sheet multi-bypass tray) Maximum: 800 sheets (300 sheets & optional 500-sheet tray)
Paper weight	Tray: 60 g/m ² to 105 g/m ² (16 lbs bond to 28 lbs bond) Multi-bypass tray: 55 g/m ² to 220 g/m ² (13 lbs bond to 80 lbs cover)
Warm-up time*2	29 sec.
Memory	Copy/print (shared): 512MB
Power requirements	Rated local AC voltage ±10%, 50/60 Hz
Power consumption	Max. 1.15 kW (220V to 240V), max. 1.1 kW (100V to 127V)
Dimensions (W x D x H)	MX-C300: 429 x 509 x 421 mm (16 5/8" x 20 3/8" x 16 37/64") MX-C250: 429 x 509 x 398 mm (16 5/8" x 20 3/8" x 15 43/64")
Weight (approx.)	MX-C300: 29 kg (63.9 lbs) MX-C250: 28 kg (61.8 lbs)

Copier

Original paper size	Max. A4 (8 1/2" x 14")
First copy time*3	Full colour: 18 sec. B/W: 10 sec.
Continuous copy	Max. 999 copies
Resolution	Scan*4: 600 x 600 dpi, 600 x 400 dpi, 600 x 300 dpi Print: 600 x 600 dpi Equivalent to 256 levels
Gradation	Equivalent to 256 levels
Zoom range	25% to 400% (25% to 200% using RSPF/SPF) in 1% increments
Preset copy ratios	Metric: 8 ratios (4R/4E), inch: 5 ratios (3R/2E)

SYSTEM CONFIGURATION

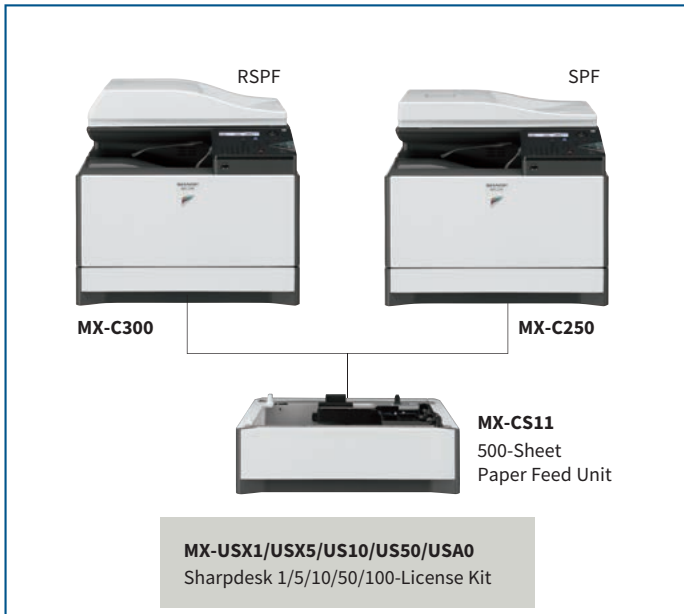

COMPACT TONER CARTRIDGES



Network Printer

Resolution	600 x 600 dpi
Interface	USB 2.0, 10Base-T/100Base-TX
Supported OS	Windows Server® 2003, Windows Server® 2003 R2, Windows Server® 2008, Windows Server® 2008 R2, Windows Server® 2012, Windows Server® 2012 R2, Windows Server® 2016, Windows® XP, Windows Vista®, Windows® 7, Windows® 8.1, Windows® 10, Mac OS 10.4, 10.5, 10.6, 10.7, 10.8, 10.9, 10.10, 10.11, 10.12, 10.13
Network protocols	TCP/IP (IPv4, IPv6)
Printing protocols*5	LPR, Raw TCP (port 9100), IPP, FTP for downloading print files
PDL	PCL 6 emulation, PostScript® 3™ emulation
Available fonts	80 fonts for PCL, 136 fonts for PostScript 3 emulation

Network Scanner

Scan method	Push scan (via control panel) Pull scan (TWAIN-compliant application)
Scan speed*6	[Colour] Max. 9 originals/min. [B/W] Max. 18 originals/min.
Resolution	Push scan: 100, 150, 200, 300, 400, 600 dpi Pull scan: 75, 100, 150, 200, 300, 400, 600 dpi 50 dpi to 9,600 dpi via user setting*7
File formats	TIFF, PDF, JPEG*8
Scanner utility	Sharpdesk
Scan destinations	Scan to e-mail/desktop/FTP server/network folder (SMB)/USB drive

*1: Short-edge feeding. *2: At rated voltage, 23°C (73.4°F). May vary depending on operating conditions and environment. *3: Short-edge feeding of A4 (8 1/2" x 11") sheets from paper tray, using document glass, MFP in fully ready condition. May vary depending on operating conditions and environment. *4: Default resolution when using document glass is 600 x 400 dpi and is 600 x 300 dpi when using RSPF/SPF. *5: IPv6 is supported only by LPR printing protocol. *6: Based on Sharp's A4 standard chart, using document feeder, short-edge feeding, and one-sided scanning. Using factory default settings with Auto Colour Selection off. Scan speed will vary depending on the type of document and the scan settings. *7: Resolution will vary depending on the size of the scanned area. Resolutions higher than 600 dpi are interpolated. *8: Colour/greyscale only.

- Design and specifications are subject to change without prior notice.
- PCL is a registered trademark of Hewlett-Packard Company. PostScript 3 is either a registered trademark or trademark of Adobe Systems Incorporated in the US and/or other countries. Windows, Windows Server, Windows Vista, Excel, and PowerPoint are registered trademarks of Microsoft Corporation in the US and/or other countries. Macintosh and Mac are trademarks of Apple Inc., registered in the US and other countries. All other brand names and product names may be trademarks or registered trademarks of their respective owners.

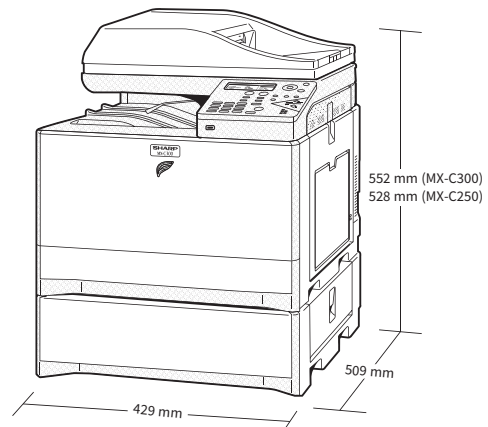

MX-C300 shown with option.

Distributed by: